



# **CM60 User Manual**

**Software Version: 1.0.0**

**Release Date: 2020/07/23**



## Content

---

Content.....	错误！未定义书签。
<b>Safety Instruction.....</b>	<b>3</b>
<b>1 Overview.....</b>	<b>4</b>
<b>2 Installation Guide.....</b>	<b>5</b>
<b>3 Reference Materials.....</b>	错误！未定义书签。
3.1 Appendix.....	6
<b>4 The Use of PC Software.....</b>	<b>7</b>
4.1 Introduction to Software.....	7
4.2 Preview.....	7
4.3 Upgrade.....	8
<b>5 To Use with Devices.....</b>	<b>9</b>
5.1 Video call.....	9
5.2 Taking photos.....	9
5.2 Video recording.....	9
<b>6 Trouble Shooting.....</b>	<b>13</b>

## Safety Instruction

---

Please read the following safety notices before installing or using this unit. They are crucial for the safe and reliable operation of the device.

- ❖ Please use the external power supply that is included in the package. Other power supply may cause damage to the phone and affect the behavior or induce noise.
- ❖ Before using the external power supply in the package, please check the home power voltage. Inaccurate power voltage may cause fire and damage.
- ❖ Please do not damage the power cord. If power cord or plug is impaired, do not use it because it may cause fire or electric shock.
- ❖ Do not drop, knock or shake the phone. Rough handling can break internal circuit boards.
- ❖ This phone is design for indoor use. Do not install the device in places where there is direct sunlight. Also do not put the device on carpets or cushions. It may cause fire or breakdown.
- ❖ Avoid exposure the phone to high temperature or below 0°C or high humidity.
- ❖ Avoid wetting the unit with any liquid.
- ❖ Do not attempt to open it. Non-expert handling of the device could damage it. Consult your authorized dealer for help, or else it may cause fire, electric shock and breakdown.
- ❖ Do not use harsh chemicals, cleaning solvents, or strong detergents to clean it. Wipe it with a soft cloth that has been slightly dampened in a mild soap and water solution.
- ❖ When lightning, do not touch power plug, it may cause an electric shock.
- ❖ Do not install this phone in an ill-ventilated place. You are in a situation that could cause bodily injury. Before you work on any equipment, be aware of the hazards involved with electrical circuitry and be familiar with standard practices for preventing accidents.

## 1 Overview

---

CM60 is a HD USB video camera with 2 Mega Pixels and 1080P resolution, which is suitable for Fanvil high-end phones. It is simple and easy to install on IP phone, LCD monitor and desk. CM60 doesn't need to be installed additional driver software. It can be flexibly installed on IP phone, LCD monitor and desk, and its camera angle is adjustable. Featuring a privacy shutter switch, CM60 provides users a secure and high-quality video communications.

## 2 Installation Guide

---

The CM60 can be used by plugging directly into the USB port of the device via USB cable. It can be placed on the desktop, hung on the phone or monitor for use. You can also set the privacy switch to adjust the camera angle as needed.

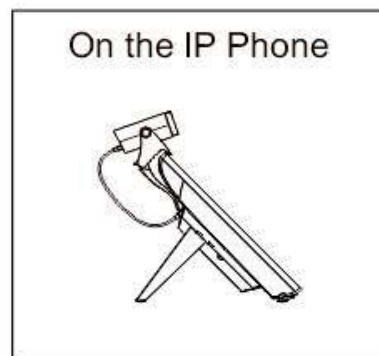
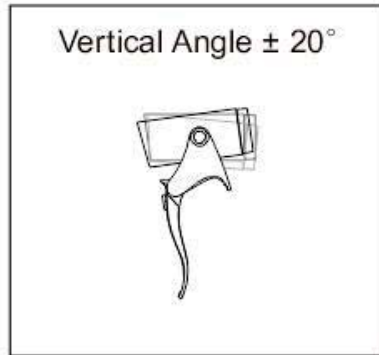

### 3 Reference Materials

---

#### Technical parameters

- Video features: 2 million pixels
- Video encoding: H.264
- Video call resolution: 1080P@30fps
- Auto/manual white balance
- Automatic exposure compensation
- Privacy adjustment switch

#### Perspective:

- Diagonal: 102°
- Horizontal viewing angle: 94°
- Vertical viewing angle: 62°
- Vertical adjustment angle: ±20°

#### Other physical characteristics

- Color: dark gray
- Status indicator (with dual-color LED light)
- Power supply: 5V/600mA (via USB interface)
- Working temperature: -10~50°C
- Working humidity: 10~90%

### 3.1 Appendix

You can check the current mode according to the camera LED instructions.

#### *description of status prompts*

LED indication	description
Steady green	Standby mode
Steady red	Working mode, such as video call, photo taking and video recording
Flashing red	camera tampering
Red->Orange	When starting, red is displayed first, then orange, When entering standby mode, green is always on.
Red and green flashing alternately	During upgrade

## 4 The Use of PC Software

---

The camera supports upgrade, preview and parameter setting through PC software developed by Fanvil.

### 4.1 Introduction to Software

USB Camera Tools is an application that installed on the PC ,which can find the camera and manage the camera.It can preview images, capture images, upgrade versions, and set camera parameters.

### 4.2 Preview

Plug the USB camera into the USB port of the PC. Double click on the PC to open USB Camera Tools, and click the start button below the software to preview the camera image.

The red arrow in the figure points to the start button.

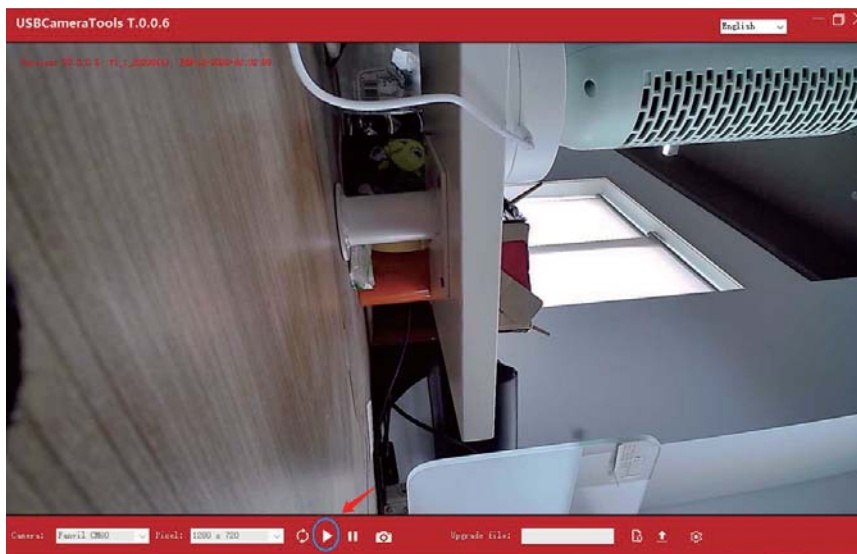

### 4.3 Upgrade

Select the file that you want to upgrade, click Open to upgrade, the software will prompt "device upgrading, please do not operate". During the upgrade process, the red and green indicator lights of the device flash alternately, the upgrade is completed, the PC will prompt to complete, click OK to complete the operation. The green light of the device is always on and it can be used normally.

The red arrow in the figure points to the version upgrade path selection.

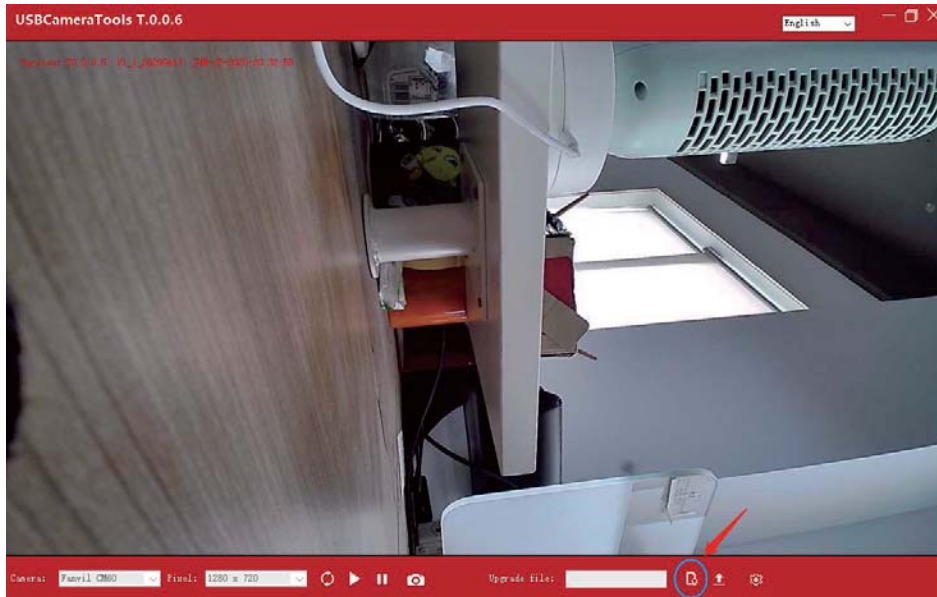



## 5 To Use with Devices

CM60 supports to use with high-end products, supports video call, photo taking, video recording and other functions. Third party apps for high-end products can also use cameras directly

### 5.1 Video call

To work with Fanvil high-end phones, plug the USB directly into the USB port of the Fanvil device. When you select to make a video call, or select video answer, you can enter the video call interface.

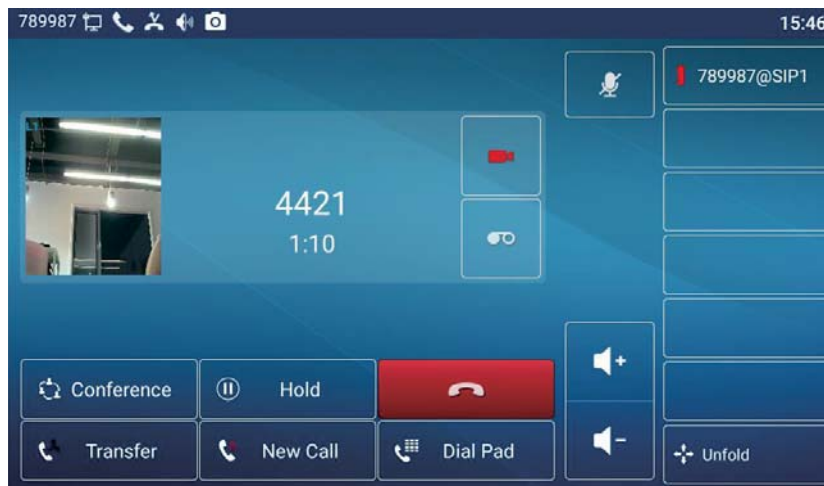

### 5.2 Taking photos

Insert the USB directly into the Fanvil X7A device, enter the X7A application list and find Camera. Tap Camera and slide your finger from left to right.,there will be options for taking photos or videos. Select Camera to enter the photo mode. The default is camera interface.

Click the photo icon on the right to take a photo. Swipe from right to left to preview the picture, and the picture is saved in the phone album.

Figure 1: X7A application list interface

Figure 2: X7A camera selection interface

Figure 3: X7A camera interface

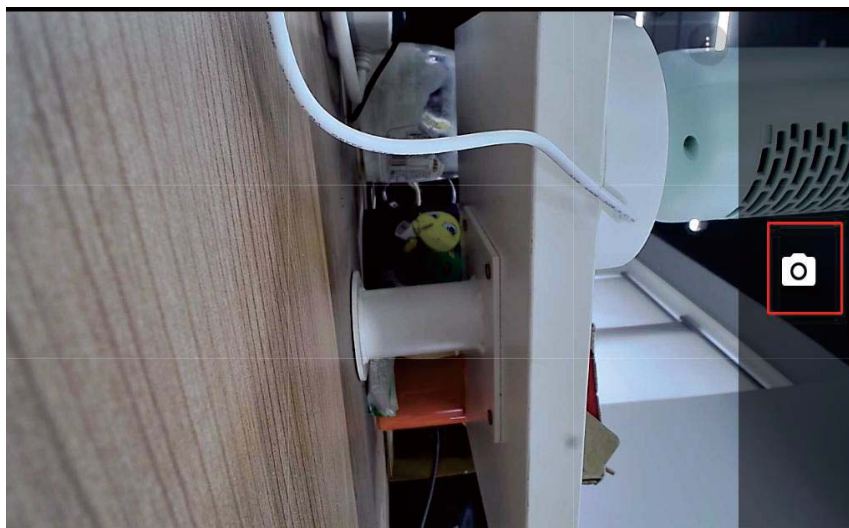
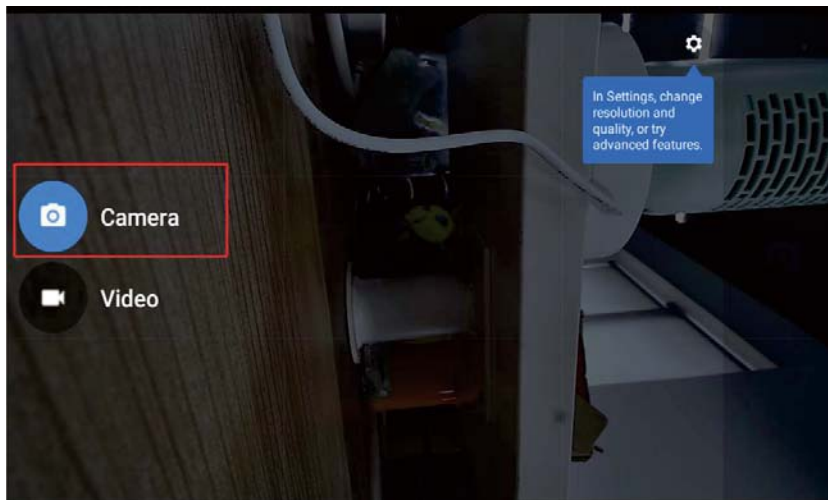
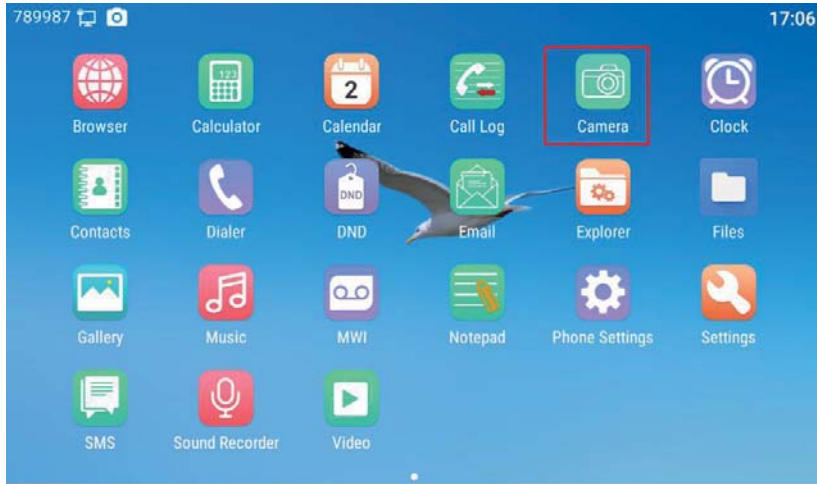

### 5.3 Video recording

Enter the X7A camera interface, slide your finger from left to right, select Video, and enter the video mode. Click the camera icon on the right to record. After the recording is complete, click stop icon to end. Swipe from right to left to view the video or view it in the phone album.

Figure 1: X7A camera selection interface

Figure 2: X7A video mode, click start to start recording.

Figure 3: During X7A recording, click Stop to end the recording.

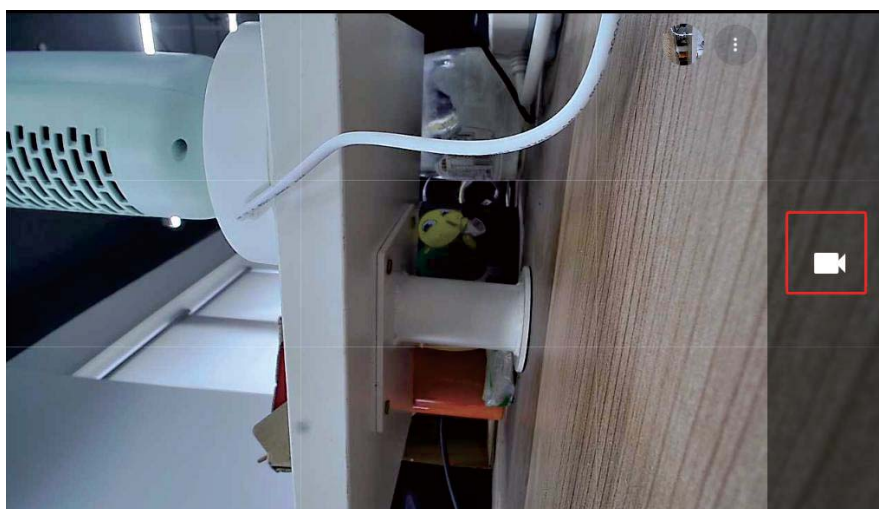
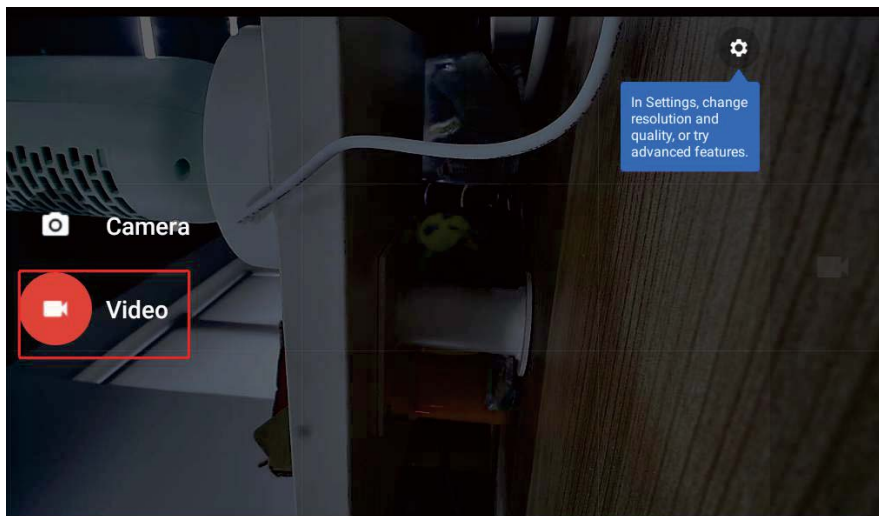



## 6 Trouble Shooting

---

Trouble Case	Solution
The camera does not show images	<ol style="list-style-type: none"><li data-bbox="513 365 1380 454">1. Check whether the USB interface is loose and confirm that there is no connection problem.</li><li data-bbox="513 454 1380 544">2. Check whether the cover in front of the camera covers the camera.</li><li data-bbox="513 544 1380 633">3. Check whether the prompt light of the camera is green and always on, and confirm that the device is working normally.</li></ol>